



Reusable Particulate Respirator

# User Instructions

1-603-314-8180 www.envomask.com support@envomask.com

## WARNING

**IMPROPER USE AND CARE OF THIS RESPIRATOR RENDERS THE RESPIRATOR INEFFECTIVE AND MAY LEAD TO SICKNESS, INJURY AND/OR DEATH. FOR PROPER USE INSTRUCTIONS REFER TO THE USER INSTRUCTIONS OR VISIT THE WEBSITE WWW.ENVOMASK.COM OR CALL 1-877-421-7337. WHEN CALLING FROM OUTSIDE THE USA, PLEASE CALL 1-603-314-8180**

90113 Rev G

**IMPORTANT: THIS PARTICULATE RESPIRATOR PROTECTS AGAINST AIRBORNE PARTICULATES. BEFORE USE, USER MUST READ AND UNDERSTAND THESE USER INSTRUCTIONS.**

**PERMITTED USES:** Use for protection from non-toxic particles such as those from grinding, sanding, sweeping, pollen, bagging, or processing minerals and/or materials as coal, iron ore, metal, flour, grains, wood, and certain other substances. Additionally, can be used for liquid or non-oil based particles from sprays that do not emit oil aerosols or vapors. Follow all applicable local regulations. For additional information visit our website at www.envomask.com or call 1-877-421-7337. When calling from outside the USA, please call 1-603-314-8180.

**PROHIBITED USES:** Do not use for protection from gases and vapors, oil aerosols, asbestos, or sandblasting; particulate concentrations that exceed either 5 times the occupational exposure limit or applicable government regulations, whichever is lower. In the USA **DO NOT** use when the Occupational Safety and Health Administration (OSHA) substance specific standards, such as those for arsenic, cadmium, lead in the construction industry, or 4,4'-methylenedianiline (MDA), specify other types of respiratory protection. This respirator does not supply oxygen and does not breathe for the user.

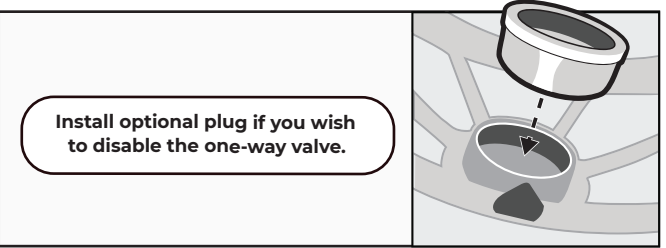

## Box Contents

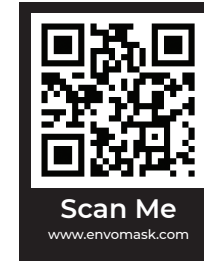
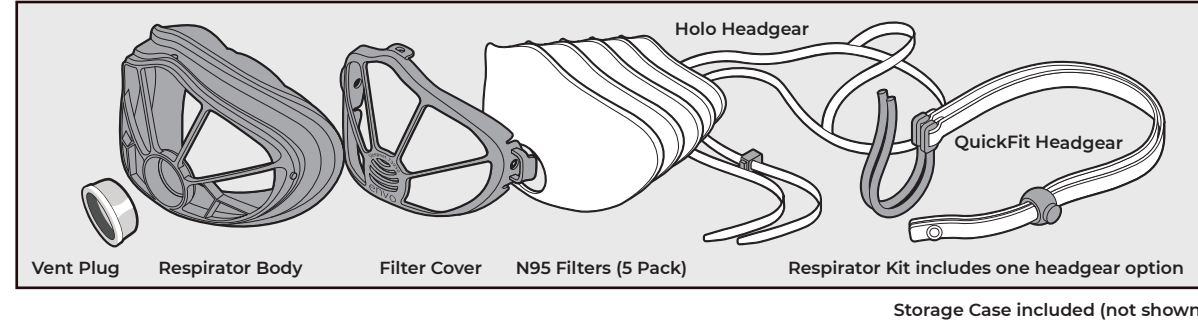

envo mask  
www.envomask.com

**BIOLOGICAL PROTECTION:** This respirator may help reduce inhalation exposure to certain airborne biological particles (e.g. mold, etc.) but cannot eliminate the risk of contracting infection, illness, or disease. OSHA and other government agencies have not established safe exposure limits for these contaminants.

### USER INSTRUCTIONS:

- Failure to follow all instructions and limitations during the use of this respirator and/or failure to use this respirator during times of exposure can reduce or eliminate respirator effectiveness and may result in sickness, injury, and/or death.
- Before occupational use of this respirator a written respiratory protection program must be implemented meeting all governmental requirements. United States employers must comply with OSHA 29 CFR 1910.134 which includes medical evaluation, training, and fit testing. Follow all applicable local regulations.
- Particles which can be dangerous to the health of the user include those that are not visible. These particles pose a significant threat to the health of the user. As such, the user and/or employer shall always consider whether or not an environment requires additional or different respiratory protection.
- Inspect respirator before use to ensure that it is in good operating condition. Examine all the parts of the respirator for signs of tears, breakage, or other damage. This includes the QuickFit headgear, Holo headgear, exhalation valve, AIRgel® cushion, and filter. Inspect the filter prior to each and every use to ensure there are no holes or damage from misuse or improper storage, and it is not soiled and/or clogged. Verify the exhalation valve is flat inside the valve port as shown in **Figure F**. If any parts are damaged or the filter is soiled and/or clogged, replace it.
- Conduct a user seal check as described in **H4** and **Q3** before use as specified in the Fitting Instructions section. **DO NOT** use the respirator if conditions exist that prevent a good seal between the face and the AIRgel® cushion of the respirator.
- Leave the contaminated area immediately if dizziness, irritation, or other distress occurs.
- This respirator is designed for occupational use by adults who are properly trained in their use and limitations. This respirator is not designed to be used by children.
- Individuals with a compromised respiratory system, such as asthma or emphysema, should consult a physician and must complete a medical evaluation prior to use.
- Store the respirator and sealed filters in the storage case away from contaminated areas when not in use. Unused filters should always be stored in the sealed poly bag (provided). **ALWAYS** examine all parts of the respirator and filters for signs of tears, breakage, clogging, soiling, or other damage after storage, prior to use.
- Dispose of soiled/clogged filters and damaged parts in accordance with applicable regulations.

### STORAGE CONDITIONS:

Before use, store respirators in the original packaging, away from contaminated areas, dust, sunlight, extreme temperatures, excessive moisture and damaging chemicals. **ALWAYS** inspect the respirator and conduct a user seal check before use as specified in **USER INSTRUCTIONS**. If you cannot achieve a proper seal, **DO NOT** use the respirator.

### USE LIMITATIONS:

- This respirator does not supply oxygen. **DO NOT** use in atmospheres containing less than 19.5% oxygen.
- DO NOT** alter, abuse or misuse this respirator.
- DO NOT** use with beards, other facial hair, or other conditions that prevent a good seal between the face and the sealing surface of the respirator.
- This respirator can help protect your lungs against certain airborne contaminants. It will not prevent entry through other routes such as the skin, which would require additional personal protective equipment (PPE).
- This respirator does not contain PVC, DEHP, or phthalates. If the user has ANY reaction to any part of the respirator, discontinue use immediately.

### SERVICE LIFE LIMITATIONS:

**DO NOT** use a single filter, continuously or intermittently, for more than a maximum of 8 hours. In heavily contaminated environments the filter may reach its maximum load more rapidly. The user must be aware of the filter load throughout use. If the filter reaches maximum load and breathing becomes labored, immediately leave the contaminated environment and replace the filter with a new filter.

This is a reusable particulate respirator. Different environments affect the useful life span of the respirator at different rates. As such, inspect the respirator before each use to ensure the respirator is ready for effective use. **DO NOT** use the respirator without inspecting the respirator for effective use, as using a compromised respirator may result in sickness, injury or death.

### CLEANING:

**DO NOT** wash filters. Filters are not reusable. All other components, including the QuickFit and Holo headgear, can be hand washed with mild soap and water. Air dry.

**IMPORTANT: AFTER WASHING, INSPECT THE EXHALATION VALVE TO ENSURE THE VALVE REMAINS PROPERLY FITTED AND LYING FLAT, SEALING THE VALVE PORT. DO NOT USE THE RESPIRATOR IF THE EXHALATION VALVE IS DAMAGED OR NOT PROPERLY FITTED.**

This respirator does not contain components made from natural rubber latex.

Sleepnet Corporation  
Hampton, NH USA 03842  
1-877-421-7337

THESE RESPIRATORS ARE APPROVED ONLY IN THE FOLLOWING CONFIGURATIONS:

TC	Protection <sup>1</sup>	Respirator Components						Cautions and Limitations <sup>2</sup>
		Alternate Filter Cover	Filter	Mask Assembly	Alternate Headgear	Accessories		
84A-9346	N95	X	X	X	X	X	X	ABCLMNDP
84A-9348	N95	X	X	X	X	X	X	ABCLMNDP
84A-9386	N95	X	X	X	X	X	X	ABCLMNDP
84A-9387	N95	X	X	X	X	X	X	ABCLMNDP

**1. Protection**  
N95- Particulate Filter (95% filter efficiency level) effective against particulate aerosols free of oil; time use restrictions may apply.

**2. Cautions and Limitations**  
A- Not for use in atmospheres containing less than 19.5% oxygen.  
B- Not for use in atmospheres immediately dangerous to life or health.  
C- Do not exceed maximum use concentrations established by regulatory standards.  
D- Failure to properly use and maintain this product could result in injury or death.  
E- Follow the manufacturer's User Instructions for changing cartridges, canister and/or filters.  
F- All approved respirators shall be selected, fitted, used, and maintained in accordance with MSHA, OSHA and other applicable regulations.  
G- Never substitute, modify, add or omit parts. Use only exact replacement parts in the configuration as specified by the manufacturer.  
H- Refer to User's Instructions, and/or maintenance manuals for information on use and maintenance of these respirators.  
I- NIOSH does not evaluate respirators for use as surgical masks.

13030 Rev E

## Attention

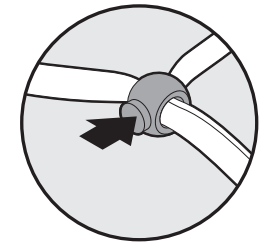

**Warning: To avoid premature wear on the headgear cord, depress cord lock button completely prior to making any adjustments.**

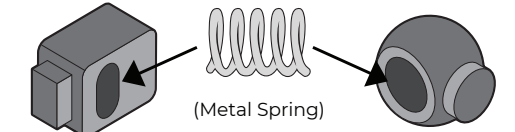

**Both Holo and QuickFit Headgear cord locks have an internal metal spring. Remove cord lock in places where metal is a hazard such as MRI and X-Ray machines.**

## Respirator Assembly

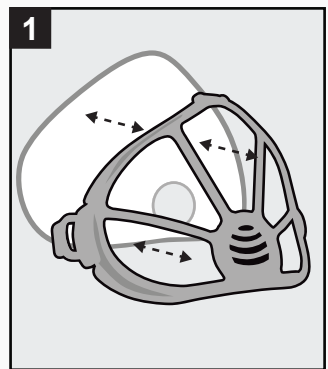

Insert filter in filter cover with the writing facing outward. Filter must lay flat to avoid any open gaps. Inspect filter after installed in filter cover as shown in **Figure F**.

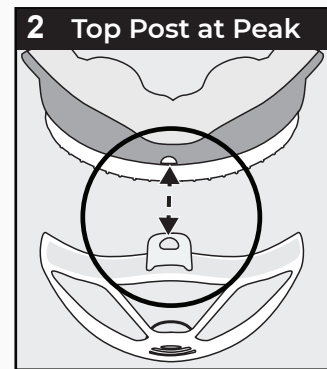

Inspect one-way valve inside the body as shown in **Figure V**. Insert position clip on the top of the filter cover over body position pin.

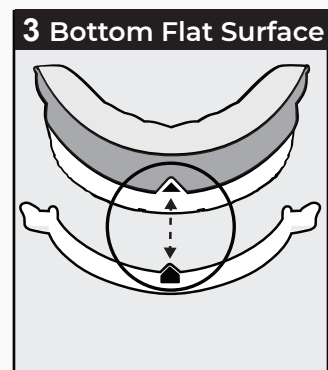

Align bottom arrows on body and filter cover. Press together until the arrows fully overlap.

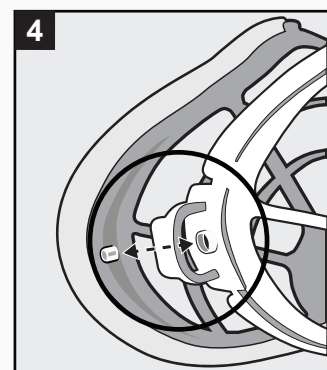

Press slot/release tab until an audible click is heard. Repeat other side. Recheck filter and confirm it is laying flat as shown in **Figure F**.

## Headgear

You have chosen one of the two headgear options for your envo mask, Holo or QuickFit. Visit [www.envomask.com](http://www.envomask.com) to purchase the additional option as an accessory.

### Holo

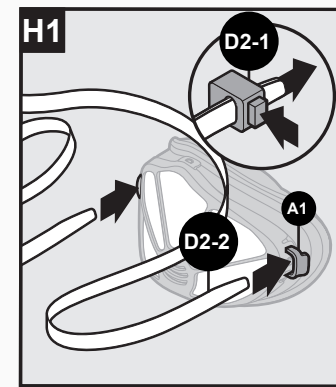

Remove cord lock (D2-1) from the strap. Thread one tapered end (D2-2) through each headgear slot/release tab (A1) on the envo mask.

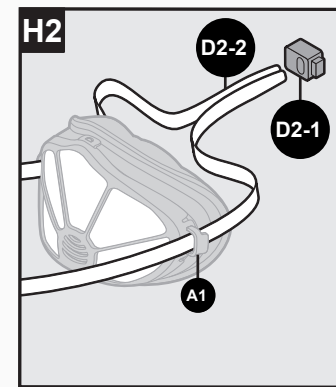

Take both Holo headgear tapered ends (D2-2) and thread through cord lock (D2-1) at the same time.

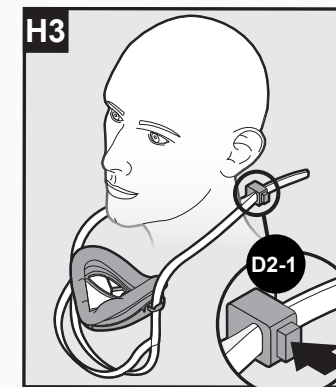

Place headgear over head wearing it like a necklace. Allow respirator to lay on chest with AIRgel® cushion facing up. Widest side of triangle should be on chest with gel facing out. Use cord lock (D2-1) until respirator is approximately 4 inches below your neck.

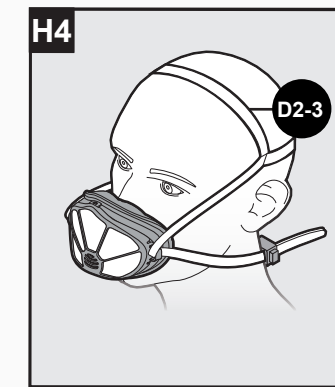

Grasp the Holo headgear and pull it over your head. Use hands to align respirator on your face properly. Adjust cord lock for a secure fit and a good seal. Place hands over filter to block air and inhale. AIRgel® cushion should compress during inhale.

### QuickFit

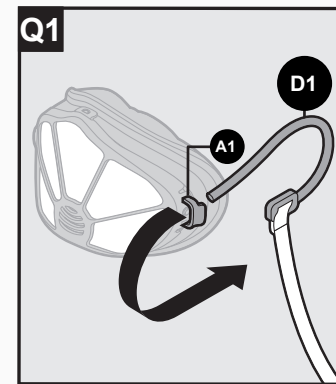

Hold the respirator with filter facing outward. Gently slide the ear clip with the elongated end through the headgear slot/release tab (A1). Repeat on the other side.

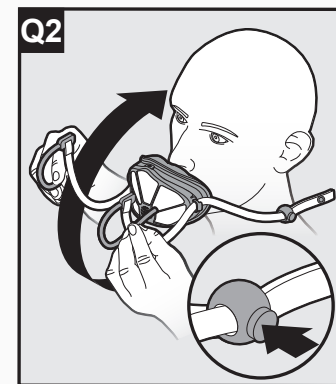

Place headgear over head wearing it like a necklace. Rest respirator on chest with AIRgel® cushion facing up. Adjust cord lock until respirator is approximately 6 inches below neck.

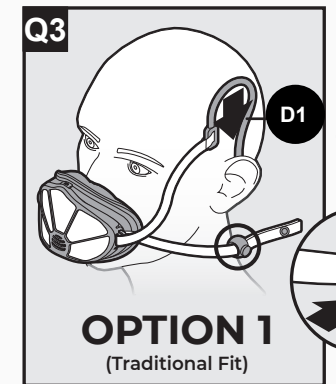

For the **traditional** fit hold one ear clip (D1) in each hand, then hook each ear clip over your ears simultaneously. For the **alternative** fit, hold one ear clip (D1) in each hand, then hook clips together and place behind head. Place hands over filter to block air and inhale. AIRgel® cushion should compress during inhale.

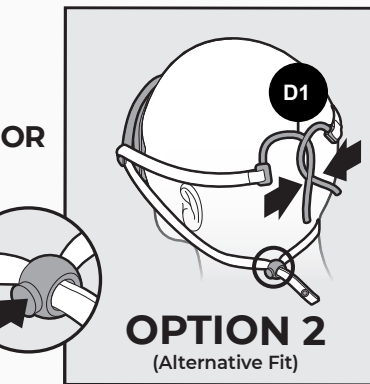

## How To Remove Cover For Filter Change

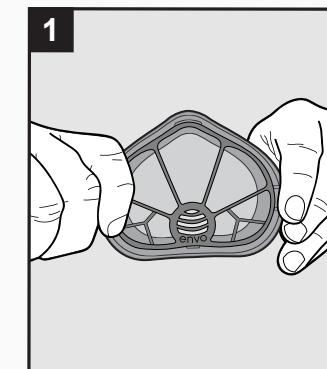

Place thumb behind headgear slot and rest finger on support structure. It is not necessary to remove headgear when changing filter.

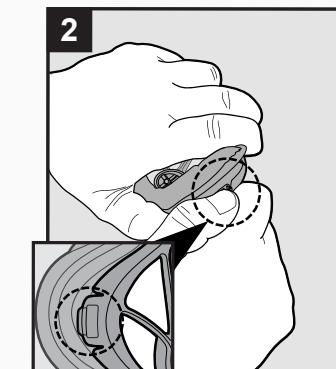

Place other hand on respirator, cushion and near headgear slot.

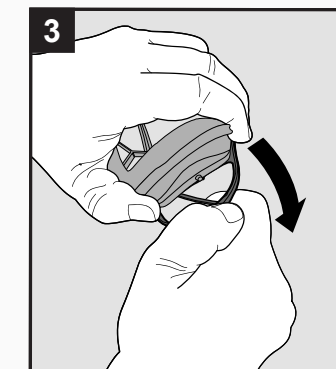

Place the respirator on a flat surface with the AIRgel® cushion side up. Peel headgear slot using thumb and separate filter cover and respirator body. Index finger may press slightly into support structure. Follow assembly instructions to reassemble respirator.

## Inspect Filter and One-Way Valve During Assembly

Figure F

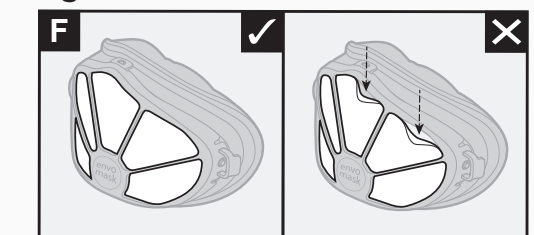
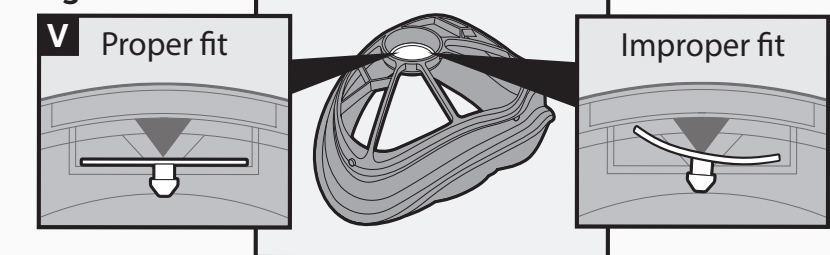

Figure V



Please visit <https://envomask.com/instructions> for additional assembly guidance. Sleepnet Corporation | Hampton, New Hampshire | USA | 1-603-314-8180 | support@envomask.com